

Accuphase

E-305V

INTEGRATED STEREO AMPLIFIER

- Output Stage Consisting of 3 Power MOSFET Parallel Push-Pulls Delivering 130 W/ch (into 8-ohm loads)
- Low Load Impedance Design
- DC Servo Directly Coupling from MC Input to Output
- Logic Relay Assembly Making Shortest Signal Path



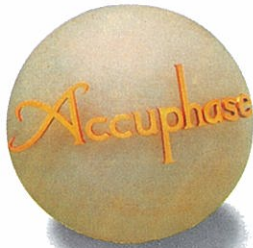

Output stage consisting of 3 parallel push-pull circuits with power MOSFETs powerfully driving loads with an impedance as low as 2 ohms. Complete construction with directly coupled unit amplifiers. Pure and straight configuration from input to output. Remote Commander as an accessory. The world can now witness the emergence of this integrated stereo amplifier with performance so great that it rivals the quality of stand-alone amplifiers.

The E-305V Integrated Amplifier is the cream of Accuphase's crop of state-of-the-art development technology. This new Integrated Amplifier was developed based on its predecessor, the E-305, but incorporates far more sophisticated features than those of the E-305.

As its name implies, an integrated amplifier combines two amplifiers, a preamplifier and a power amplifier, into a single chassis. Naturally, this makes operation easier and saves installation space. However, it is very difficult for an integrated amplifier to achieve the electric characteristics on par with those of stand-alone amplifiers. The biggest reason for this difficulty is that the total gain of the integrated amplifier exceeds 100 dB, which can cause mutual interference and cross talk among internal units.

However, we, at Accuphase, have finally found a solution that satisfies even the severest audiophile demands. Drawing on our tradition of building separate-type amplifiers of world renown, we have used only the finest materials and applied innovative design to create this new Integrated Amplifier. Consequently, the E-305V has the quality of a stand-alone preamplifier and power amplifier in an integrated package.

Additionally, the power amplifier and the preamplifier of the E-305V can be used independently of each other if so set with a selector switch on the rear panel.

The output stage of the power amplifier is made of three parallel push-pull circuits per channel. These push-pull circuits consist of MOSFETs. Accuphase has a long tradition of using power MOSFETs. In 1978, we developed an integrated stereo amplifier, the E-303, using power MOSFETs for the first

time in the world. Since then, Accuphase has introduced many models employing MOSFETs, all of which have enjoyed an excellent reputation.

A MOSFET has a high input impedance. Therefore, when MOSFETs are used in the output stage of an amplifier, the workload of the preceding stage, the driver stage, is significantly alleviated, so that the driver stage can drive the output stage in an ideal manner. The excellent high-frequency characteristics of the MOSFET offer superb sound quality and its different atmosphere from that of bipolar transistor is highly interesting to hifi enthusiasts. Another notable feature of the MOSFET is the negative temperature coefficient. This means that the MOSFET has an excellent environmental durability. For those reasons, Accuphase has employed MOSFETs again in creating this new Integrated Amplifier which can deliver 130 watts per channel into 8-ohm loads, 180 watts into 4-ohm loads, and as much as 250 watts into 2-ohm loads. In addition, the E-305V is also equipped with a stable, complementary differential push-pull input circuit, a high-capacity power transformer, and filter capacitors, to drive loads with low impedance ratings.

The preamplifier is equipped with a phono equalizer amplifier for analog discs so that both MC and MM cartridges can be used. To linearly amplify the signals input from such sources as CD players and tuners, highly stable cascode differential FET input is used for a high-level amplifier. An independent regulated power supply circuit is provided to each of the L and R channels to prevent mutual interference among the amplifiers, which would otherwise occur through the power supply circuit.

For the volume control, Accuphase has developed a new potentiometer consisting of, distortion-free and mirror-like polished rotating resistive element and a fixed brush, unlike the ordinary potentiometer which is made of a rotating brush and fixed resistive elements. By fixing the brush, the number of metal contact points have been reduced. This contributes significantly to the improvement of sound quality. In addition, this volume control device features a gear mechanism and motor, so that it can be controlled by the Remote Commander supplied as an accessory. This Remote Commander can also control the input selector and attenuator. The input selection is made by gold-clad twin cross-bar relays

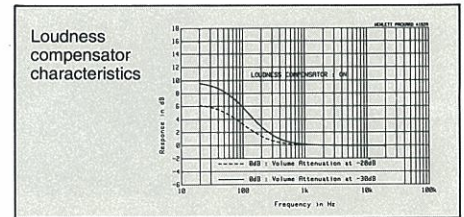

which are remote-controlled with a logic circuit—another consideration to improve sound quality.

Generally, tone controls are thought to deteriorate sound quality. The tone controls of the E-305V, however, are of the summing active filter type, which are also employed in Accuphase's Graphic Equalizer G-18. With these tone controls, the music signals do not go through the filter circuit, but only the necessary quantity of the signals are filtered (summed) to prevent degradation of sound quality. The loudness compensator ideally performs level weighting according to the volume.

In the Accuphase tradition, the front panel of E-305V is finished in hair-line polished gold with the natural persimmon side panels creating warm atmosphere. Large power meters are arranged in the center of the front panel, flanked by the input selector to the left and a large volume control knob to the right for ergonomic consideration. Switches for less frequently used functions are arranged behind a hinged subpanel.

Powerful 3-Parallel Push-Pull Power MOSFET Output Stage Ideal for Driving Low-Impedance Loads

Figure 1 shows the circuit design of the E-305V power amplifier. N-channel power MOSFETs (Q_{17} , Q_{19} , and Q_{21}) and P-channel power MOSFETs (Q_{16} , Q_{18} , and Q_{20}) are arranged in 3-parallel push-pull configuration. MOSFETs are voltage-controlled devices. Since the carrier of electrons is different from that of bipolar transistors, MOSFETs have good high frequency characteristics and a high switching speed. The temperature coefficient of a MOSFET is negative, which means that the drain current does not increase with temperature, making the MOSFET free from current concentration and thermal runaway. Moreover, unlike the bipolar transistor, the second breakdown does not take place in a MOSFET in the high voltage region, and therefore, the MOSFET can guarantee a wide area of safe operation.

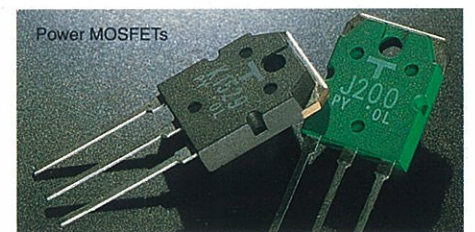

By using such power MOSFETs in parallel configuration, ample power can be supplied to low-impedance loads. Consequently, the E-305V can deliver 130 watts per channel into an 8-ohm loads, 180 watts into a 4-ohm loads, and as much as 250 watts into 2-ohm loads.

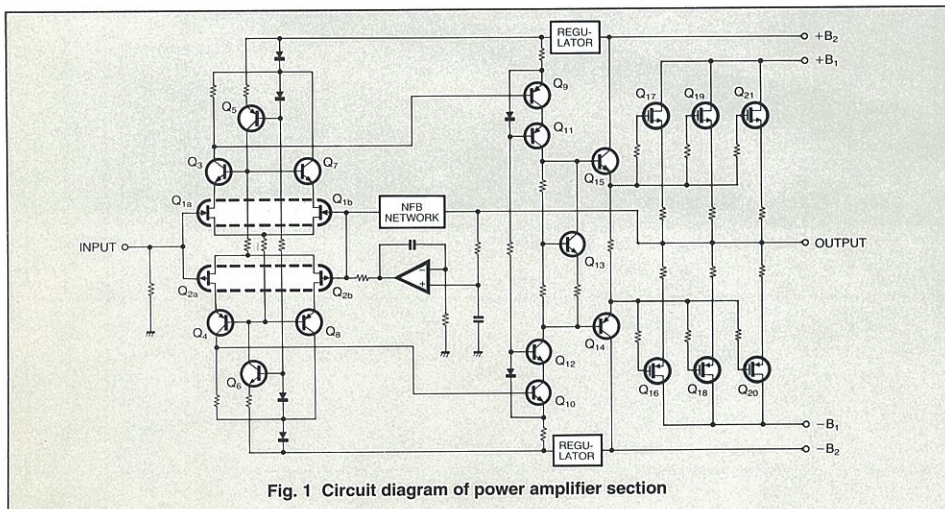

Fig. 1 Circuit diagram of power amplifier section



Cascode-Connected Driver Stage for Ideal Driving of Power MOSFETs

Cascode connection is usually employed in high-frequency circuits. However, Accuphase has employed this connection in the E-305V's driver stage, which consists, as shown in Figure 1, of Q₉, Q₁₁, and Q₁₅, as well as Q₁₀, Q₁₂, and Q₁₄. The performance of these elements (transistors) can be fully appreciated by minimizing the phase shift in this stage and by keeping the voltage VCE applied to the input device of the cascode stage to a low level. Consequently, the linear characteristics can be maintained over a wide band of frequencies, so that the power MOSFETs in the output stage can be driven in an ideal manner.

For the input circuit, Accuphase's original complementary differential push-pull circuit is used with the input FETs connected in cascode configuration to fully draw out the high performance of the elements.

Direct-Coupled Amplifiers

All the unit amplifiers, including those for analog disc, high level, and power, are directly coupled. When all amplifiers are directly coupled, DC drift may occur in each amplifier, which adversely affects the speakers and circuits. However, this possibility is effectively precluded by separate DC servo loops for each amplifier unit, resulting in rock-stable operation. This design is ideal for optimum performance and uncolored sound.

Newly Developed Volume Control

The volume control is an important function in that it is always used each time the selector is operated and the sound source is changed. For the input level adjuster of the E-305V, Accuphase has developed an original potentiometer containing resistive elements whose surface has been polished to a mirror-like smoothness. This mirror-like finish contributes to good distortion characteristics and an excellent

anti-defacement feature. The biggest feature of this potentiometer is its rotation mechanism. Generally, a potentiometer has fixed resistive elements serving as a stator with leads going out through rivet holes, and a brush serving as a wiper. However, the potentiometer of the E-305V has rotating resistive elements with a fixed brush to provide direct external access to the brush as a terminal. Consequently, there are only three contact points instead of the ordinary five. This potentiometer contributes greatly to the improvement of sound quality. In addition, no agent that may degrade sound quality such as grease is applied between the brush and resistive elements.

Together with this quality volume control device, a gear mechanism and a motor are provided so that the volume can be controlled with the Remote Commander supplied as an accessory.

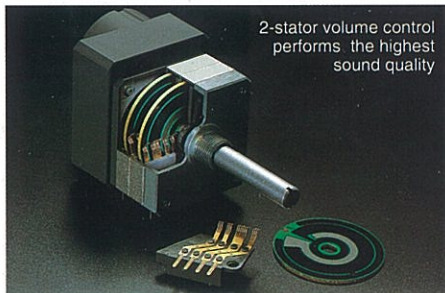

Logic Relay Control with High Reliability

Weak signals, such as those of the input selector are switched by Accuphase's original logic relay assembly. In general, a rotary switch is used to directly switch weak signals such as music signals. However, our modern living conditions are not the optimum environment for switch contacts and relays, due to the many factors that cause sulfidization and oxidization of the contacts. If these sul-

furized or oxidized contacts are used in audio equipment, they naturally degrade sound quality. In order to eliminate such adverse factors, Accuphase employs high quality relays which are encapsulated in housings containing nitrogen gas. Further, the relay can be short as possible, so that it may eliminate adverse influences depending on wiring methods and wiring materials. In addition, the relay has gold-clad contact with twin cross-bar construction, which has the same high grade parts that are employed in sophisticated communication equipment.

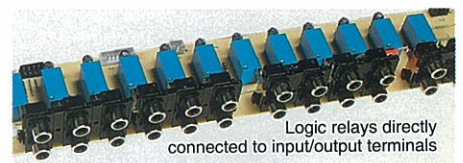

Remote Commander for Remote Control of Input Source and Volume

The E-305V is supplied with a Remote Commander as an accessory. This Remote Commander can select the input source and control the volume of the E-305V to provide mobility like that of the remote controller of a CD player or a videocassette recorder (VCR). As described earlier, the input selection is carried out by a localized relay which is driven by a logic circuit. Since the Remote Commander controls only this logic circuit without any electrical connection with the relay, there is no possibility of signal deterioration. Though the volume control is rotated silicon steel plate, in order to completely any electrical noise produced by the motor keeping the volume



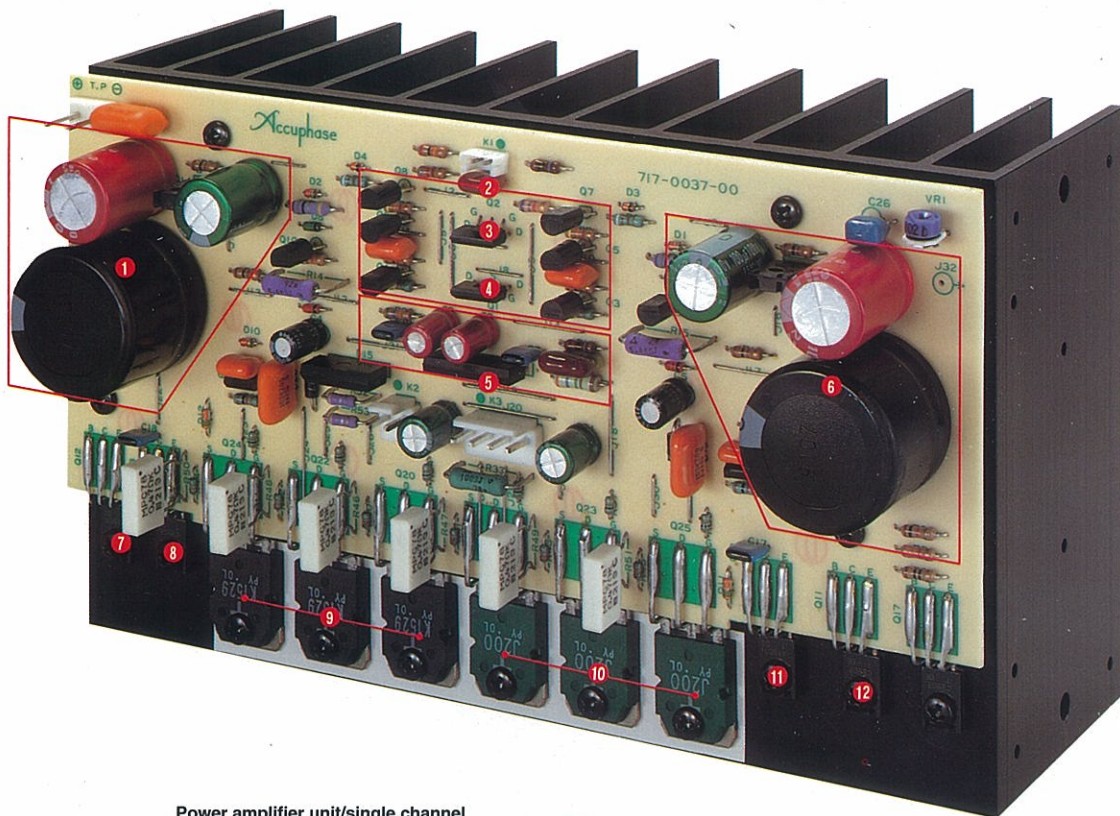

INTERNAL LAYOUT

- 1 Left channel power amplifier unit
- 2 Meter driver circuit, protection circuit board
- 3 High-capacitance filter capacitor
- 4 Toroidal power transformer
- 5 Right channel power amplifier unit
- 6 Pre-amplifier unit

Power amplifier unit/single channel

- 1 Stable power supply for output stage
- 2 Pure complementary differential cascode push-pull input circuits
- 3 N-channel 1-chip FET
- 4 P-channel 1-chip FET
- 5 Servo amplifiers
- 6 Stable power supply for output stage
- 7 Pre-drive transistor
- 8 Drive transistor
- 9 N-channel power MOSFET
- 10 P-channel power MOSFET
- 11 Drive transistor
- 12 Pre-drive transistor

control unit free from the influence of any such noise. To demodulate the remote control signals, a micro-computer is used. The timing of switching is controlled in the order of milliseconds. Consequently, there is no noise generated when the input source is switched.

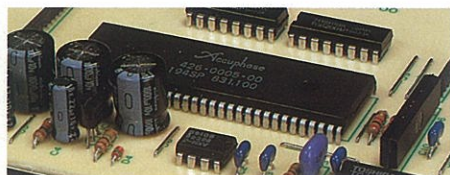

Microcomputers for controlling the timing of switching

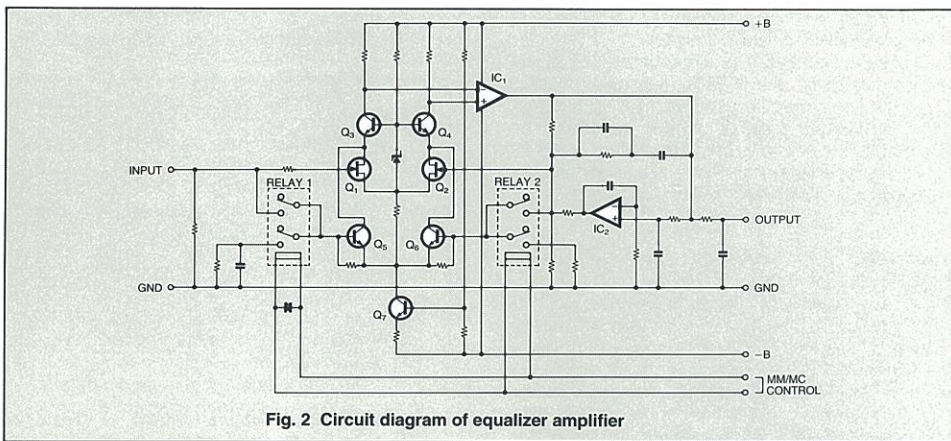

Fig. 2 Circuit diagram of equalizer amplifier

Equalizer Amplifier for All Cartridges Including MM and MC

Digital program sources are dominant today, almost making analog discs obsolete. However, for many audiophiles and music lovers, their collection of analog records is a treasure they will not easily abandon. The E-305V is therefore equipped with an "equalizer amplifier", whose performance and sound quality is polished to almost the upper limits, for reproduction of analog records. The circuit configuration of this equalizer amplifier is shown in

Figure 2. The biggest feature of this equalizer amplifier is that it is provided with an input circuit that takes the characteristics of both the MM and MC cartridges into consideration, enabling the utmost exploitation of both the MC (moving coil) and MM (moving magnet) cartridges.

When the MM cartridge is used, taking into account that the output voltage and impedance of

the MM cartridge are high, the circuit is configured with FETs (Q_1 and Q_2) that can maintain high input impedance over a wide frequency range. With the MC cartridge, on the other hand, a differential input circuit is configured of low-noise devices (Q_5 and Q_6) and the impedance of the NFB loop is designed to be low so as to handle weak signals at a low impedance for noise free reproduction.

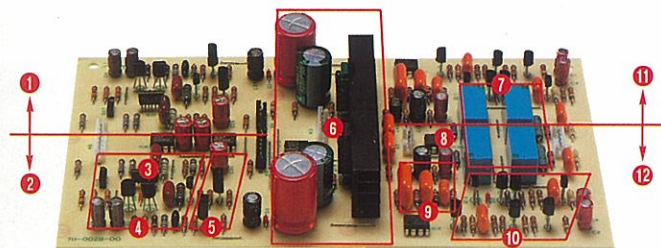

Circuit board for preamplifier section

- 1 High-level amplifiers (L-channel)
- 2 High-level amplifiers (R-channel)
- 3 1-chip FET for input differential amplifier
- 4 Input amplifiers
- 5 Output buffer amplifier
- 6 Stable power supply
- 7 MC/MM switching relay
- 8 Operational amplifier for servo amplifier
- 9 Equalizer devices
- 10 Input differential amplifiers
- 11 L-channel equalizer amplifiers
- 12 R-channel equalizer amplifiers

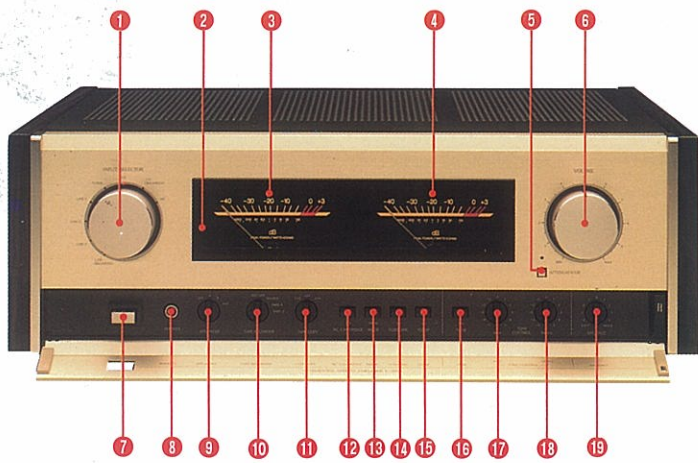

FRONT/REAR PANELS

- 1 Input selector: LINE (BALANCED), LINE-3, LINE-2, LINE-1, TUNER, CD, CD (BALANCED), AD
- 2 Remote sensor
- 3 Left channel output meter (dB div., wattage direct reading)
- 4 Right channel output meter
- 5 Attenuator
- 6 Volume control
- 7 Power switch
- 8 Headphone jack
- 9 Speaker selector: OFF, A, B, A+B
- 10 Record output/tape monitor switch: REC OFF, SOURCE, TAPE-1, TAPE-2
- 11 Tape copy switch: 1→2, OFF, 2→1
- 12 Equalizer gain selector switch: ON (MC), OFF
- 13 Stereo/monophonic selector switch
- 14 Subsonic filter: 17 Hz, -12 dB/oct
- 15 Compensator switch
- 16 Tone control switch
- 17 Bass control
- 18 Treble control
- 19 Volume balance control
- 20 Ground terminal
- 21 AD (analog disc) input jacks
- 22 CD (unbalanced) input jacks

- 23 Tuner input jacks
- 24 LINE-1 input jacks
- 25 LINE-2 input jacks
- 26 LINE-3 input jacks
- 27 TAPE-1 tape input jacks
- 28 TAPE-1 recording output jacks
- 29 TAPE-2 tape input jacks
- 30 TAPE-2 recording output jacks
- 31 Preamp input jacks
- 32 Power amplifier input jacks
- 33 Preamp/power amplifier separation switch
- 34 Right channel output terminals for speaker A
- 35 Left channel output terminals for speaker A
- 36 CD (balanced) input connectors XLR-3-31 or equivalent: (1) Ground, (2) Inverted (-), (3) Non-inverted (+) Applicable connectors: XLR-3-12C or equivalent
- 37 Line (balanced) input connectors
- 38 AC outlet (associated with power switch)*
- 39 Right channel output terminal for speaker B
- 40 AC outlet (not associated with power switch)*
- 41 AC power cable
- 42 Left channel output terminal for speaker B

***Remarks:**
These switched and unswitched AC outlets may not be supplied depending on the safety standards or regulations applicable in the particular country or where the unit is desired.

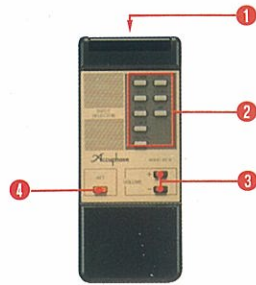
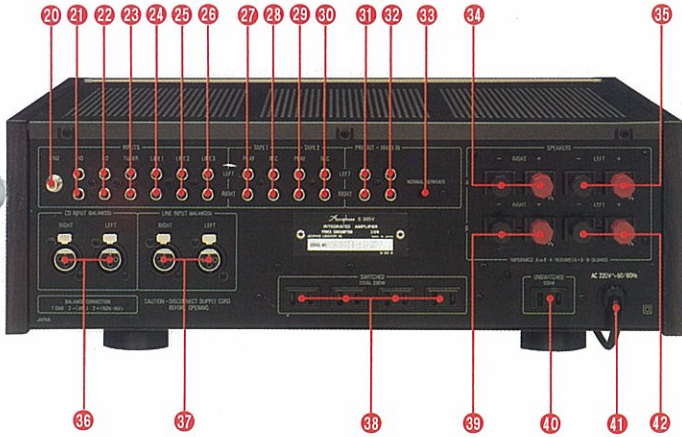

Remote Commander RC-8

- 1 LED transmitting section
- 2 Input selector keys
- 3 Volume control keys
- 4 Attenuator key

Input/Output Terminals Permitting Separate Use of Preamp and Power Amplifier

A set of input and output terminals on the rear panel permits "splitting" the E-305V into two entities. These terminals may be used to hook up external sound processors such as graphic equalizers, or they permit, for example, the combination of the E-305V's power amplifier or preamplifier with another preamplifier or power amplifier of your choice.

Tone Control of Summing Active Filter for Optimum Sound Quality

The energy balance of real-world program sources is not always constant, and it varies also depending on speaker systems and listening rooms. It is therefore convenient to have tone controls for some corrections, but audiophiles often shun such circuits as they are thought to deteriorate sound quality. The tone controls of the E-305V, however, are newly developed designs which use the same summing active filter principle found in high-quality graphic equalizers. The operating principle of these controls is shown in Figure 3. The flat signal passes straight through, and necessary characteristics are produced in F1 and F2 and added or subtracted to the signal, thereby producing the desired change. This

design provides the most excellent sound quality and efficient control without degrading signal purity.

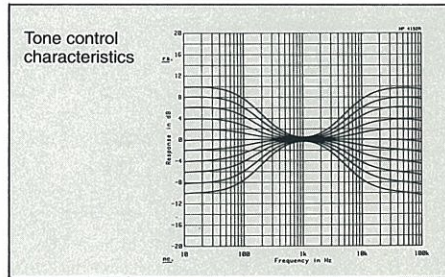

Dedicated Power Supplies for Each of Preamp Section and Power Amplifier Section

Since a preamplifier that processes weak signals and a power amplifier through which a large current flows are housed in a single case to create an integrated amplifier, interference between the two amplifiers coupled with the power supply is inevitable under ordinary circumstances. The E-305V, however, prevents this interference by employing a power supply and voltage regulator dedicated to each of the amplifiers. Preamplifiers and power amplifiers also influence each other due to capacitive coupling and electromagnetic induction. The extent of influence varies depending on the internal construction and parts layout of the integrated amplifier. Here again, Accuphase has made the best use of its design technology cultivated over years in determining the internal construction and parts layout, so as to minimize the mutual influence between the amplifiers to an unsurpassed level.

Many Input Terminals Including Balanced Inputs

To accommodate a variety of program sources, the E-305V is provided with eight pairs of input terminals

for the input selector, and two sets of terminals for connection of tape recorders. Of these input terminals, two pairs, CD and LINE, are of the balanced type. Figure 4 shows the operating principle of balanced transmission. The output circuit sends out a positive signal and a negative signal, each of which are 180 degrees out of phase. The input circuit receives and accurately mixes these two signals. Consequently, the noise that may be superimposed on the signals in the cable is canceled out when the signals are mixed since the noise components are fed into the input in-phase, thereby maintaining the purity of the music signal.

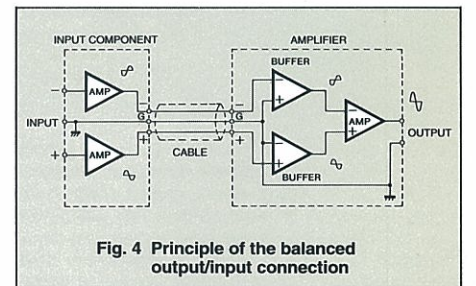

Fig. 4 Principle of the balanced output/input connection

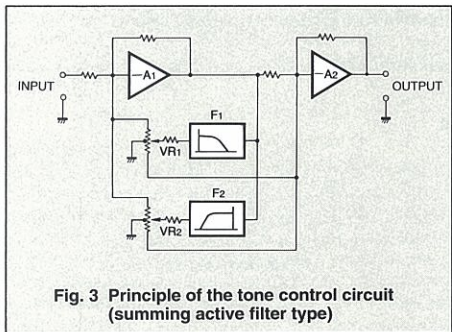
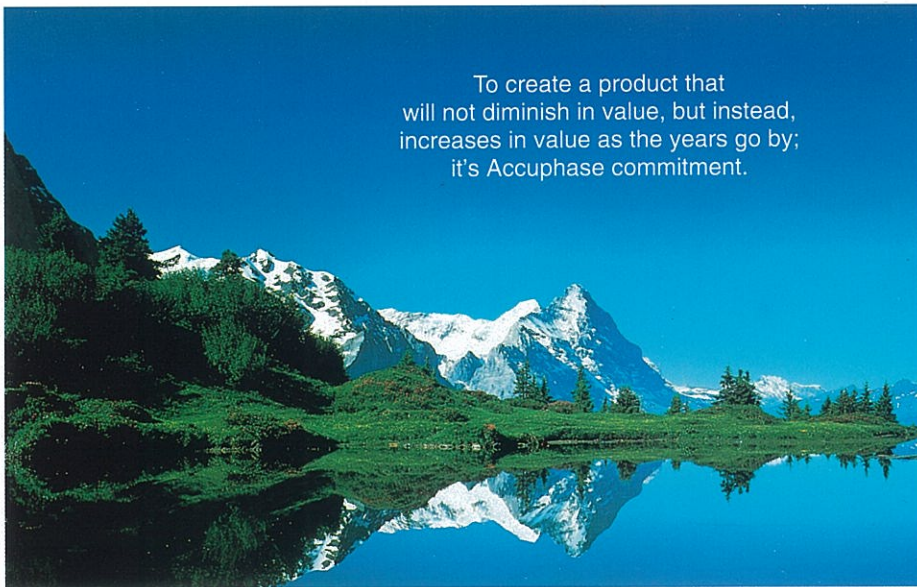

Fig. 3 Principle of the tone control circuit (summing active filter type)

Direct-Reading Peak Power Meters and Speaker Selector

The output of the power amplifier can be monitored by the two large power meters on the front panel. Since these meters are the logarithmic compression type, a wide dynamic range can be viewed at a glance. In addition, the peak reading is added for an accurate indication of power.

The speaker selector switch in the subpanel controls the selection of individual high-power relay for the speaker A or B. This selector switch also has a A+B position for bi-wiring (supplying the same signal via dual leads to speakers with separate high-frequency and low-frequency inputs).



To create a product that will not diminish in value, but instead, increases in value as the years go by; it's Accuphase commitment.

enrich life through technology

GUARANTY SPECIFICATIONS

(Guaranty specifications are measured according to EIA standard RS-490. AD denotes Analog Disc input.)

Performance Guaranty

All Accuphase product specifications are guaranteed as stated.

Continuous Average Output Power

180 watts per channel into 4 ohms
130 watts per channel into 8 ohms
(Both channels driven, 20 to 20,000 Hz, THD 0.02%)

Total Harmonic Distortion

0.02%, with 4 to 16 ohms load
(both channels driven, from 0.25 W to rated continuous average output, 20-20,000 Hz)

Intermodulation Distortion

0.01%

Frequency Response

MAIN AMP INPUT: 20 to 20,000 Hz, +0, -0.2 dB
(for rated output)
0.5 to 150,000 Hz, +0, -3.0 dB
(for 1 watt output)

HIGH LEVEL INPUT: 20 to 20,000 Hz, +0, -0.2 dB
(for rated output)

LOW LEVEL INPUT: 20 to 20,000 Hz, +0.2, -0.5 dB
(for rated output)

Damping Factor

100 (with 8-ohm load, 50 Hz)

Maximum AD Input Level

MM: 300 mV rms, 1 kHz, THD 0.005% (REC OUT)
MC: 8.0 mV rms, 1 kHz, THD 0.005% (REC OUT)

Input Sensitivity and Impedance

| Input terminal | Sensitivity | | Input Impedance |
|------------------|--------------|-----------------|-----------------|
| | Rated output | EIA (1W output) | |
| AD INPUT (MC) | 0.123 mV | 0.01 mV | 100 ohms |
| AD INPUT (MM) | 3.8 mV | 0.34 mV | 47k ohms |
| HIGH LEVEL INPUT | 125 mV | 10.9 mV | 20k ohms |
| BALANCED INPUT | 125 mV | 10.9 mV | 40k ohms |
| MAIN AMP INPUT | 1.28 V | 111 mV | 20k ohms |

Rated Output Level and Impedance

PRE OUTPUT: 1.28 V at 200 ohms
TAPE REC OUTPUT: 125 mV at 200 ohms (from AD input)
HEADPHONES: 0.4 V (suitable impedance: 4 to 100 ohms)

Gain

MAIN INPUT → OUTPUT: 28 dB
HIGH LEVEL INPUT → PRE OUTPUT: 20 dB
AD INPUT (MM) → TAPE REC OUTPUT: 30 dB
AD INPUT (MC) → TAPE REC OUTPUT: 60 dB

Tone Controls

Turnover frequency and adjustment range
BASS: 300 Hz ± 10 dB (50 Hz)
TREBLE: 3 kHz ± 10 dB (20 kHz)

Loudness Compensation

+6 dB (100 Hz) (Volume control setting -30 dB)

Subsonic Filter Characteristics

Cutoff frequency 17 Hz, -12 dB/oct

Attenuator Characteristics

-20 dB

Power Level Meters

Logarithmic compression, peak reading meters
dB and direct watt-reading (8-ohm load) scale

Output Load Impedance

4 to 16 ohms

Signal-to-Noise Ratio

| Input terminal | Input short circuit A-weighted | | EIA S/N |
|------------------|-----------------------------------|--------------------------|---------|
| | S/N with rated input | Input converted noise | |
| MAIN AMP INPUT | 124 dB | -121 dBV | 102 dB |
| HIGH LEVEL INPUT | 110 dB | -128 dBV | 83 dB |
| BALANCED INPUT | 90 dB | -108 dBV | 82 dB |
| AD INPUT (MM) | 88 dB | -137 dBV | 80 dB |
| AD INPUT (MC) | 72 dB | -150 dBV | 80 dB |

Semiconductor Complement

59 transistors, 22 FETs, 24 ICs, 69 diodes

Power Requirements

100 V, 117 V, 220 V, 240 V AC, 50/60 Hz

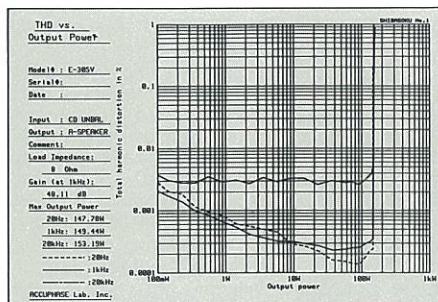

Output power vs. total harmonic distortion (at 8 ohms)

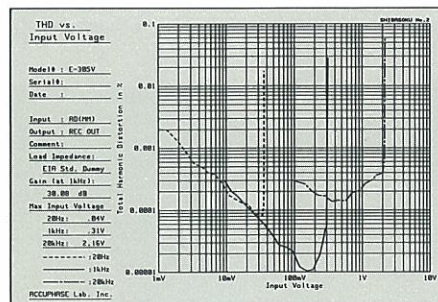

Input voltage vs. total harmonic distortion
(input: MM, output; tape output terminal)

Power Consumption

65 watts at zero signal input
310 watts in accordance with IEC-65

Dimensions

475 mm (18-23/32 inches) width,
170 mm (6-11/16 inches) max. height,
375 mm (14-49/64 inches) mm depth

Weight

22.7 kg (45.1 lbs.) net
27 kg (59.5 lbs.) in shipping carton

Remote commander RC-8

Remote control principle: infrared pulse
Power supply: 3V DC (IEC R6 batteries × 2)
Dimensions: 64 mm (2-1/2 inches) width, 149 mm (5-7/8 inches) height, 18 mm (11/16 inches) depth
Weight: 140 g (0.3 lbs.) (including batteries)

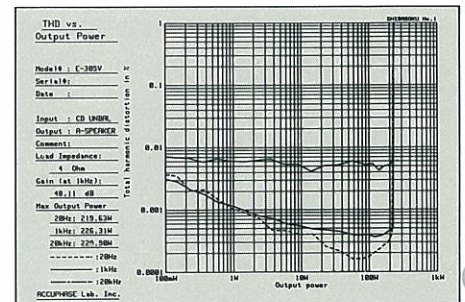

Output power vs. total harmonic distortion (at 4 ohms)

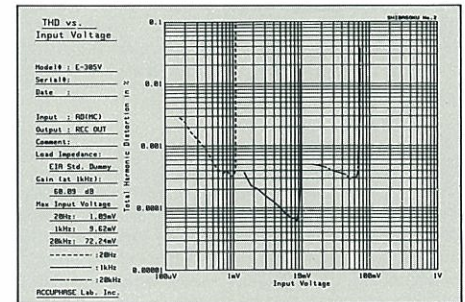

Input voltage vs. total harmonic distortion
(input: MC, output: tape output terminal)

Accuphase
ACCUPHASE LABORATORY INC.